

PRODUCTOS PARA FUNDICIÓN



CRISOL CAZOLETA

Cm.	70	80	90	95	120	140
Ref.	CRR45 01	CRR45 03	CRR45 04	CRR17 01	CRR45 02	CRR17 02



CRISOL CUADRADO

Med.	50 x 50	60 x 60	70 x 70	80 x 80	100 x 100
Ref.	CRC45 06	CRC45 05	CRC45 04	CRC45 03	CRC45 01

CRISOL DE GRAFITO PARA HORNO ELÉCTRICO DE 2 KG

Ref. CRE8502

CRISOL DE GRAFITO 1/2 KG PARA HORNO ELÉCTRICO DE 1KG

Ref. CRE170777

CRISOL DE GRAFITO PARA HORNO ELÉCTRICO DE 1 KG

Ref. CRE8502

CRISOL CARBURO SILICIO 1 KG

Ref. CRE1707777

CRISOL COMPUESTO DE GRAFITO 1 KG

Ref. CRE

CRISOL DE GRAFITO 0.8 KG PARA HORNO ELÉCTRICO

Ref. CRE5401

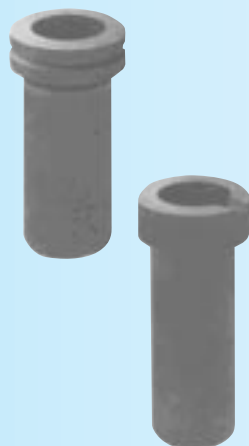

CRISOL PARA HORNO DE INDUCCIÓN

MOD. CG40

Ref. CRE1701

MOD. CG40 SUPER

Ref. CRE17011

CRISOL PARA HORNO DE INDUCCIÓN

GRAFITO Y CERÁMICA CG150

Ref. CRE1702

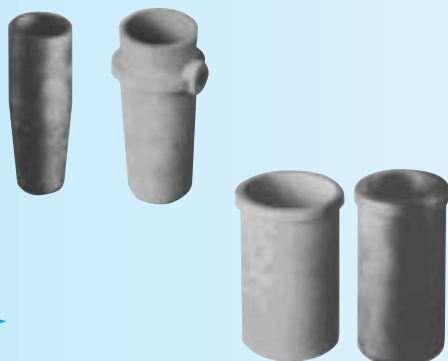

Consultar otras medidas

PRODUCTOS PARA FUNDICIÓN

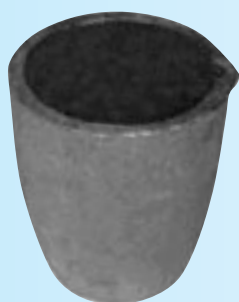

CRISOL PARA HORNO A GAS

Mod.	Referencia	Capacidad	Mod.	Referencia	Capacidad
1/0	CRS4300	1/2 Kg.	A/4	CRS4301	4 Kg.
A/1	CRS430	1 Kg.	A/6	CRS4306	6 Kg.
A/2	CRS4302	2 Kg.	A/8	CRS4308	8 Kg.
A/3	CRS4303	3 Kg.			

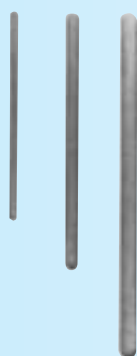

VARILLAS REMOVEDORAS

CERÁMICA FINA - 10 mm Ø **Ref. VAR1701**

CERÁMICA GRUESA - 14 mm Ø **Ref. VAR1702**

CRISTAL DE CUARZO 0,8 X 30 C - 8 mm Ø **Ref. VAR1703**

GRAFITO 10 - 10 mm Ø **Ref. VAR1704**



FUNDENTE PURIFICADOR BLANCO

Ref. FUN4302

FUNDENTE PURIFICADOR GRIS PARA RECUPERACIÓN DE LIMADURAS

Ref. FUN8401

FUNDENTE PURIFICADOR VERDE

Ref. FUN4301



TENAZAS PARA SACAR CRISOLES

Varios modelos según crisol

Ref. TEN4301



TENAZAS PARA SACAR CILINDROS

Ø CILINDROS

70 y 80

90 y 100

Ref.

TEN7701

TEN7702

PRODUCTOS PARA FUNDICIÓN

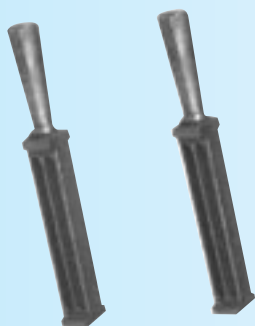

LINGOTERA TRES CANALES CON MANGO

Ref. LIN6101

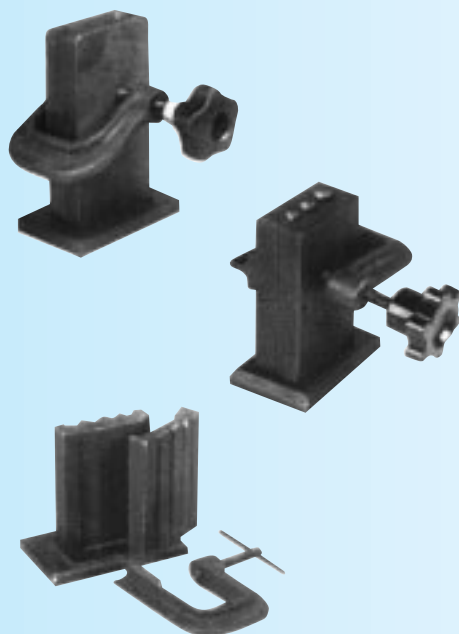

CHAPONERA CHAPA

Medidas 50 x 150 x 8mm

Ref. CHA6103

CHAPONERA HILO

Medidas hilo 8 mm x 120

Ref. CHA6102

CHAPONERA MIXTA

Medidas 30 x 100 x 6 mm
Medidas hilo 6 x 100 mm

Ref. CHA6101

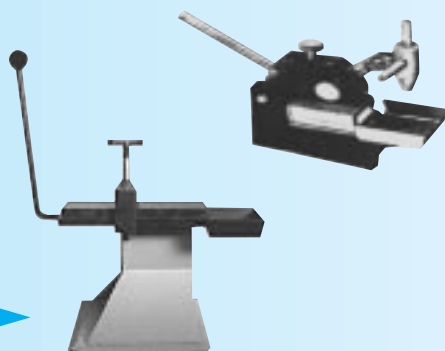

LINGOTERA BASCULANTE

Ref. LIN6508

LINGOTERA BASCULANTE Mod. ROMAR

Crisol 80 x 80 mm
Crisol 100 x 100 mm
Chapa 40 mm x 150 mm

Ref. LIN7701